



A WORLD LEADER IN FUME EXTRACTION TECHNOLOGY

ILF 300

Last Updated on 02.02.2022



Inline filter delivering a longer life for applications that generate high amounts of dust and particulate.

The BOFA inline pre-filters have been designed specifically for applications that generate high amounts of dust or particulate. The filter unit is positioned alongside the main BOFA fume filtration system to increase the overall filter capacity and extend the life of the main filters. A range of application-dependent filter types and configurations are available on request.

Technology



ProTECT service plan



SureCHECK quality standard

Key features of the ILF 300

Extended filter life Standard

Large filtration area Standard

Technical specification

1. Inlet - 125mm

2. Lid

3. Filter compartment hinges

4. Exhaust outlet - 125mm

Contact BOFA at <https://bofainternational.com/en/contact/>

<https://bofainternational.com/en/portal/datasheets/ilf-300/>





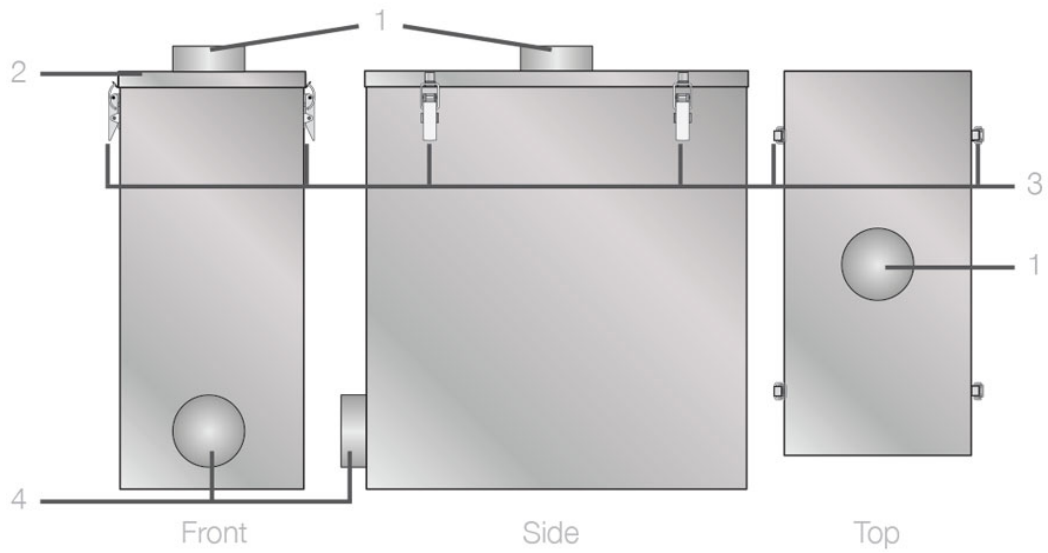

Approvals: REACH and RoHS. See individual product technical data for specific accreditations

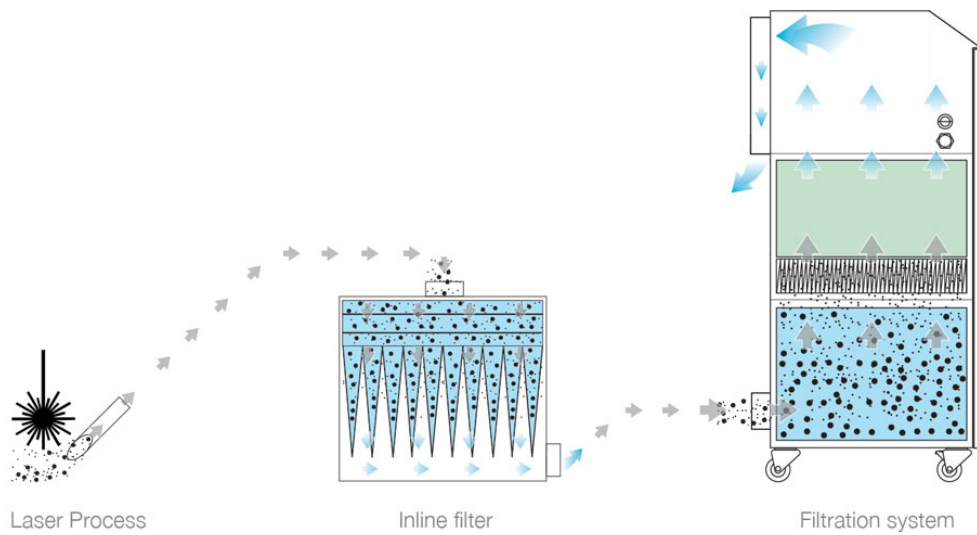

Inline filtration system



Airflow through filters

-  Pre-filter
-  Clean air
-  Contaminated air
-  Particulate

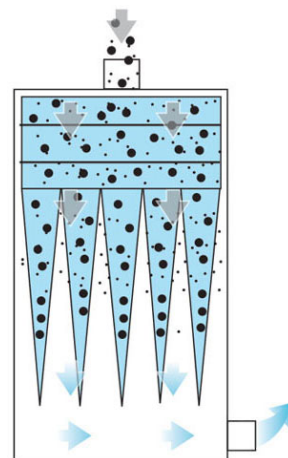

Technical data

	EU	US
Dimensions (HxWxD)	796 x 638 x 328 mm	31.34 x 25.12 x 12.92"

Technical data

Cabinet construction	Stainless steel	Stainless steel
Weight	27kg	60lbs
Exhaust outlet	125mm	4.9"

Pre-filter (lower grade) specifications

Filter media construction	Bag filter
Filter efficiency	82% @ 1 microns

Pre-filter (higher grade) specifications

Filter media construction	Pleated filter
Filter efficiency	95% @ 0.9 microns

Unit part numbers

Model	Part number
ILF 300 with a 5 pocket filter, stainless steel - lower grade	A1030069
ILF 300 with a 5 pocket filter, stainless steel - higher grade	A1030436

Replacement filter part numbers

Lower grade pre-filter	Higher grade pre-filter
A1030132 (5 pocket)	A1030290 (5 pocket)

Other languages

ILF 300
[French](#)

Datasheet correct at time of publishing.

Where applicable, the carbon used in BOFA units is capable of removing a wide range of VOCs, however it is the responsibility of the user to ensure the carbon is suitable for their application. For specific applications, please contact us for details.

Important Notice: *Many factors beyond the control of BOFA can affect the use and performance of BOFA products in a particular application, including the conditions under which the product is used. Since these factors are uniquely within the user's knowledge and control, it is essential the user evaluate the products to determine whether the product is fit for the particular purpose and suitable for the user's application. All products, product specifications, availability and data are subject to change without notice, and may vary by region or country.*

Think before you print! Please consider the environment before printing this document.

