



A Donaldson Company

A WORLD LEADER IN FUME
EXTRACTION TECHNOLOGY

FumeCAB 700 (115v)

USER MANUAL



Contents

V2 Jan 16

1	01	Overview of your Extraction system (front)
	02	Overview of your Extraction system (back)
2	01	Important safety notes
	02	Safety labels
3	01	Unpacking and unit placement
4	01	Unit information and connecting to mains
5	01	Turning extractor on / Changing display units
6	01	Cleaning the unit / Pre filter replacement
	02	Combined filter replacement
7	01	Consumable spares / Filter Disposal
8	01	FumeCAB 700 specifications

Overview

1 01

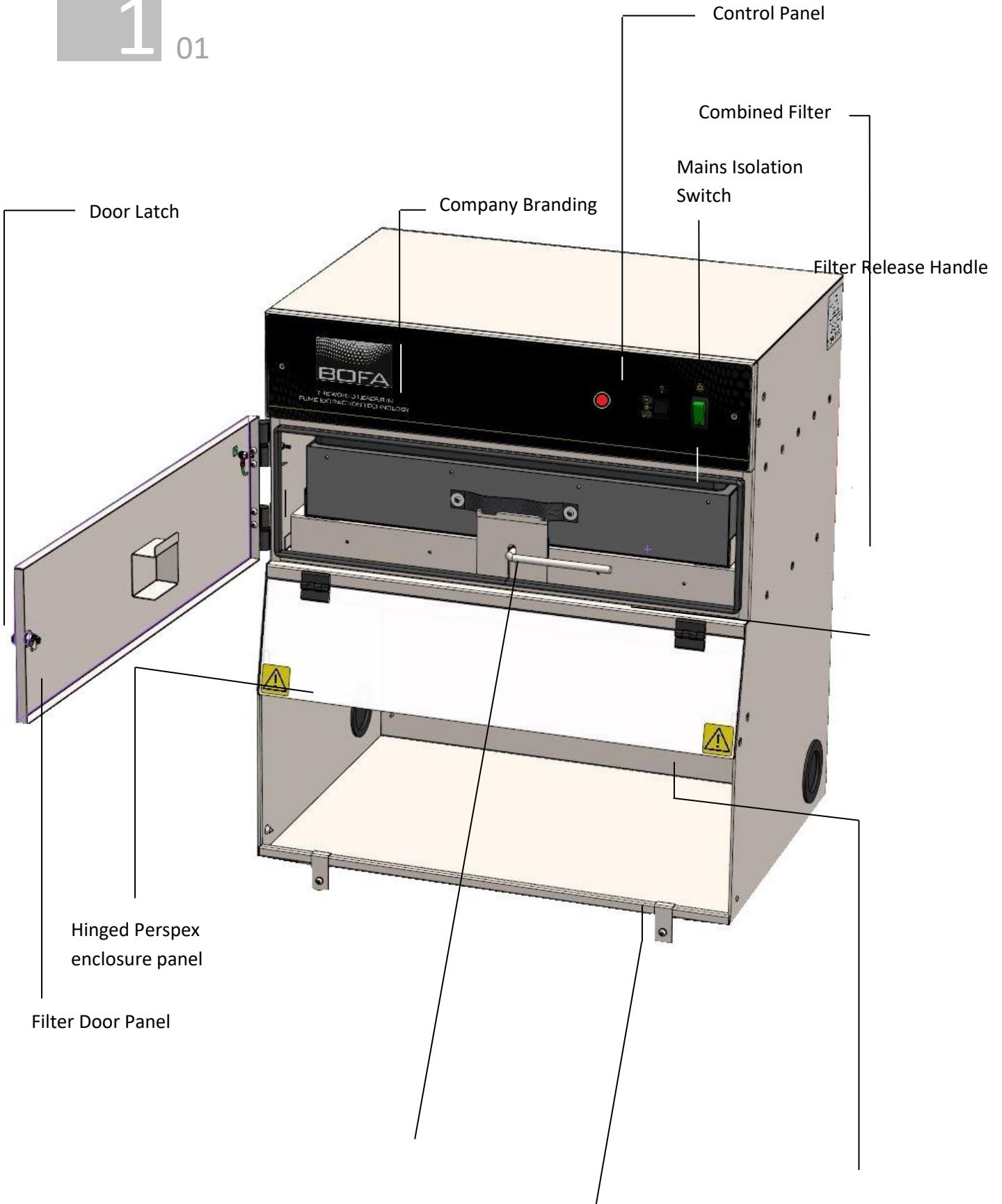

Pre Filter —

Air Inlet

Inlet for
Tools/Equipment/Cables

Overview

1 02

Mains Inlet

Motor Cooling

Air outlet

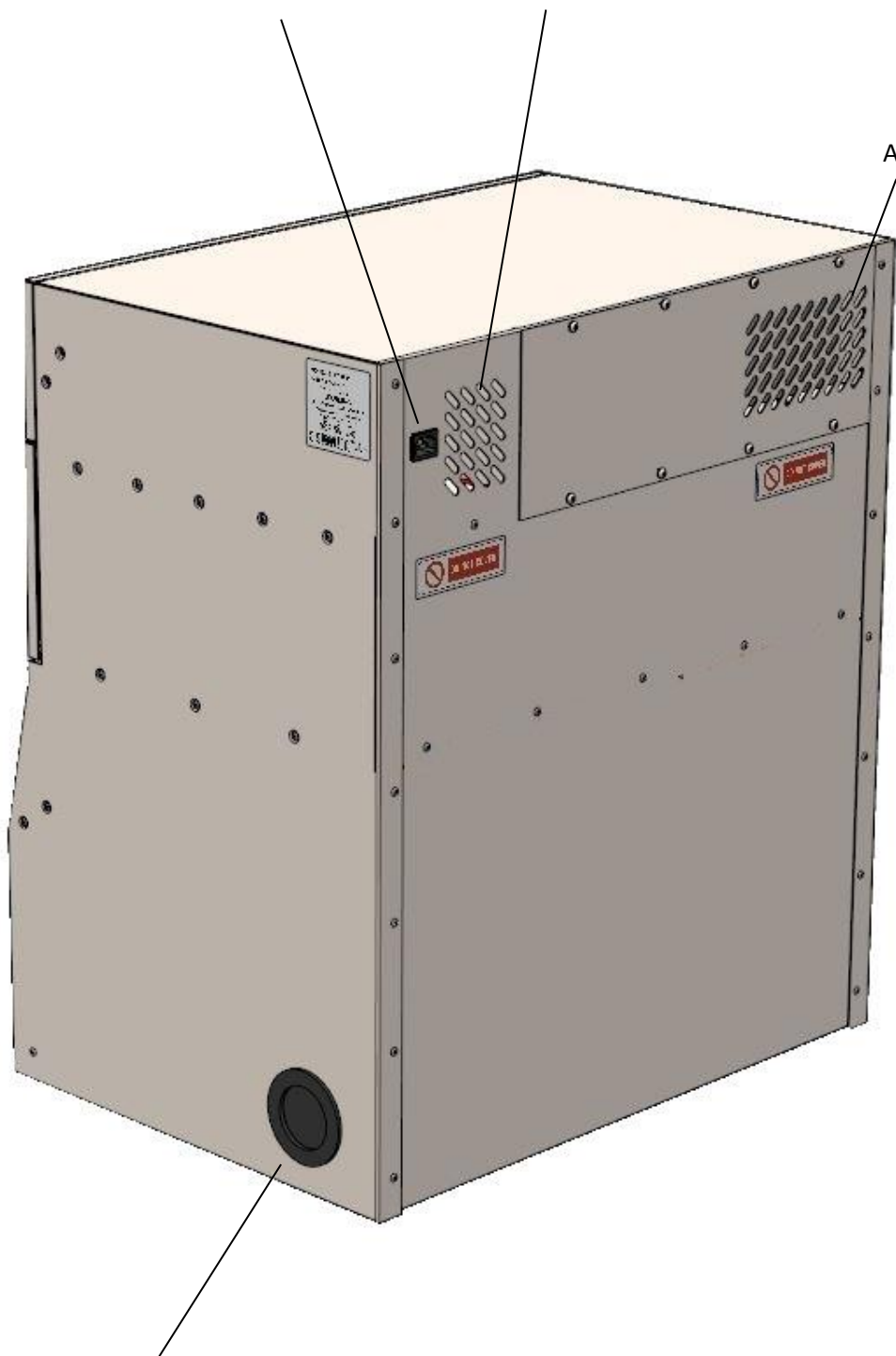

Overview

1 03

Main Isolation Switch

Filter Change Indicator

Lighting Switch

Company Branding



Safety Instructions



Important safety notes

Concerning symbols used on the extraction unit and referred to within this manual.



Danger

Refers to an immediately impending danger. If the danger is not avoided, it could result in death or severe (crippling) injury. Please consult the manual when this symbol is displayed.



Warning

Refers to a possibly dangerous situation. If not avoided it could result in death or severe injury. Please consult the manual when this symbol is displayed.



Caution

Refers to a possibly harmful situation. If not avoided, damage could be caused to the product or something in its environment.



Important (Refer to manual)

Refers to handling tip and other particularly useful information. This does not signify a dangerous or harmful situation. Refer to manual when this symbol is displayed.

Electrical Safety

The FumeCab 700 system has been designed to meet the safety requirements of the Low Voltage Directive 2006/95/EC (previously numbered 73/23/EEC)

Warning

When working with the pump/motor housing open, Live 230/115 volt mains components are accessible. Ensure that the rules and regulations for work on live components are always observed.

Important

To reduce the risk of fire, electric shock or injury:

1. Always isolate the system from the mains power supply before removing the pump/motor access panel.
2. Use only as described in this manual.
3. Connect the system to a properly grounded outlet.

Dangers to eyes, breathing and skin

Once used, the filters within the FumeCab 700 system may contain a mixture of particulates, some of which may be sub-micron size. When the used filters are moved it may agitate some of this particulate, which could get into the breathing zone and eyes of the operative. Additionally, depending on the materials being used, the particulate may be an irritant to the skin.

This unit should not be used on processes with sparks of flammable materials or with explosive dusts and gases, without implementation of additional precautions.

Caution: When changing used filters always wear a mask, safety shoes, goggles and gloves.

Carbon selection

Please note that the media within the gas filter fitted in the FumeCab 700 is capable of adsorbing a wide range of organic compounds. However, it is the responsibility of the user to ensure it is suitable for the particular application it is being used on.

BOFA Technical Service

If a problem arises with your FumeCab 700 system please:

- Visit our website at www.bofa.co.uk for on-line help.
- Or contact the helpline on **+44 (0) 1202 699 444**, Mon-Fri, 9am-5pm.
Email: Technical@bofa.co.uk
- For USA helpline contact: (618) 205-5007

Serial Number

For future reference, fill in your system details in the space

F U M E C A B 7 0 0 - [] [] []

provided. The serial number is on the rating label located on the side/rear of the unit.

Serial Number:

Location: Door panel, Perspex door

Meaning: Power should be isolated before the panel with this label attached is opened/ removed.

Safety Instructions



Warning and Information labels

The following listing details labels used on your FumeCab 700 unit.

Goggles, Gloves & Mask Label



Location: Front face of both filters

Meaning: Goggles, Gloves and Masks should be worn while handling used filters.

Do Not Cover Label



Location: Rear motor cooling panels and rear left corner of unit

Meaning: Do not cover any louvers or holes adjacent to the label.

Electrical Danger



Location: Upper control panel.

Meaning: Removal of panels with this label attached will allow access to potentially live components.

Warning Label



Serial Number Label

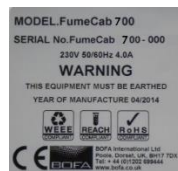

Location: Top left corner of back panel.

Meaning: This label contains a variety of information about the extraction unit, including.

- Company name, Address & Contact number
- Extractor model
- Unit serial number
- Operating voltage range
- Maximum current load
- Operating frequency
- Year of Manufacture
- Relevant approval markings/ logos

PLEASE NOTE: If the equipment is used in a manner not specified by the manufacturer, the protection provided by the equipment maybe compromised.

Fire Risk Warning

In the very rare event that a burning ember or spark is drawn into the fume extraction unit, it may be possible that the filters will ignite.

Whilst any resultant fire would typically be retained within the fume extraction unit, the damage to the extractor could be significant. It is therefore essential to minimise the possibility of this occurring by undertaking an appropriate Risk assessment to determine:-

- a). Whether additional fire protection equipment should be installed.
- b). Appropriate maintenance procedures to prevent the risk of build-up of debris which could potentially combust.

This unit should not be used on processes where sparks could occur, with explosive dusts and gases, or with

particulates which can be pyrophoric (can spontaneously ignite), without implementation of additional precautions

It is essential that nozzles or other extraction/ fume capture devices and hoses/pipework are cleaned regularly to prevent the build-up of potentially ignitable debris

Before installation

3₀₁

Packaging Removal & Unit Placement

Before installation check the extraction unit for damage. All packaging must be removed before the unit is connected to the power supply.

Please read all instructions in this manual before using this extractor.

1. Move the unit to the location where it is going to be installed and remove the outer packaging. **This unit should be installed in a well-ventilated area.**
2. Open the front door.
Check the filters are located in their correct position before closing the door and securing the door latches.
Note: The door will not close fully if the Combined filter has not been secured in place using the internal lever. (As detailed below)

Ensure that 500 mm space is available around any vented panels on the extractor to ensure adequate airflow.

 **Caution**
Due to the weight of the extractor suitable lifting equipment should be used and with regard to appropriate safety precautions. (See Appendix for product weight details)

 **Caution**
Under no circumstances should the exhaust outlet/s be covered as this will restrict the airflow and cause overheating.

 **Caution**
Do not block or cover the cooling vents on the unit, as this severely restricts airflow and may cause damage to the unit.

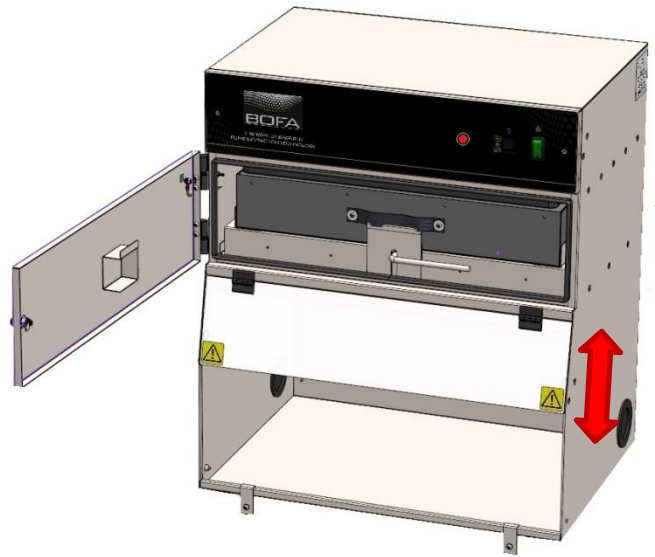

The FumeCab 700 features a hinged transparent Perspex panel on the front of the unit. This allows for more room to place larger work pieces inside the unit when working, while not restricting the user's vision.

Installation

4 01

The FumeCab 700 has been designed to remove and filter fume containing potentially hazardous particulate and gases generated during manufacturing processes. Such hazardous substances are captured within a multistage filtration system after which the cleaned air is returned to the workplace.

The FumeCab 700 captures the fume acting as an enclosure or cabinet. The user is working on the work piece from inside the unit instead of externally through the use of ductwork.

Specification

Dimensions: Height 780mm Depth 490mm Width 690mm

Weight: 70Kg

Voltage: 115V

Frequency: 60Hz

Full load current: 3A

Power: 320W

Face Velocity: 0.4 M/Sec

Connection to Power Supply

Please follow the above specification when selecting the power supply outlet for the extraction system, ensure the power supply is suitable before connecting the extraction unit.

Check the Integrity of the electrical power cable, if the supply cord is damaged the extraction unit should not be connected to the mains. The supply cord should only be replaced by a BOFA engineer as an electrical safety test may be required after replacement.



The extraction unit **MUST** be connected to a properly earthed outlet.

Connect the power cable to an isolated electrical supply. The mains socket should be installed near the extractor it should be easily accessible and able to be switched On/ Off. The cable run should be arranged so as not to create a trip hazard.

Optional Stand

A powder coated mild steel stand/trolley is available as an optional extra for the FumeCab 700. The stand allows easy transportation on four castors at an ideal working height.

ESD Compliant FumeCAB 700

An ESD compliant version of the FumeCAB 700 is also available. This unit features an internal anti-static mat with lead termination points. The unit is also painted in an ESD compliant paint finish.

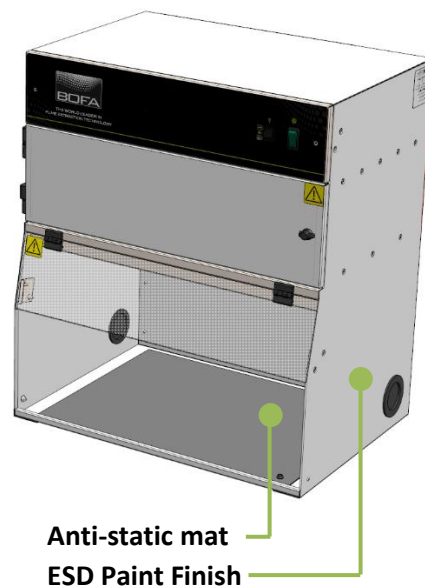

FumeCAB 700 Conformal Coating

A conformal coating upgrade is available as an optional extra for the FumeCAB 700 unit. This involves the installation of dark coloured magnetic screens and a UV light inside the working area within the unit to make the conformal coating application process easier.

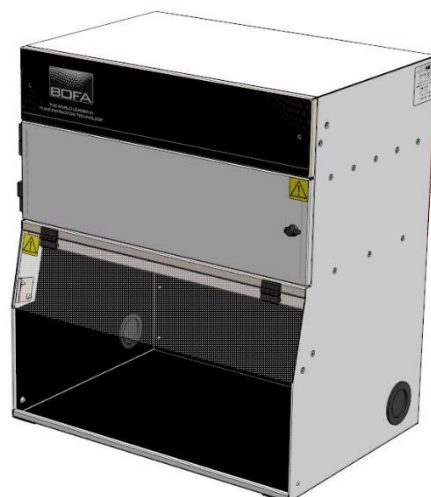

Operation

5₀₁

Turning extraction unit On

To turn on the extraction unit, the main isolation switch must be switched to the "On" position, the top side of the switch should be depressed to power the unit.

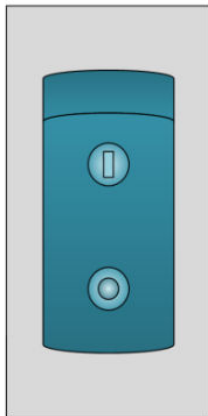

Please Note: To ensure efficient airflow, the FumeCab must be used with the clear panel in the down position.



The extractor and all pipe work must be fully installed and connected before the airflow is set.

Maintenance



Maintenance UK

It is a legal requirement, under regulation 9 of the COSHH regulations that all local exhaust ventilation systems are thoroughly examined and tested at least once every 14 months (typically carried out annually). The approved code of practice recommends that a visual check should be carried out at least once a week.

COSHH requires the annual inspection and testing to be carried out by a competent person and specifies that documentation results are recorded in a log.

Contact the seller for more information about inspection and certification.

Maintenance General

User maintenance is limited to cleaning the unit and filter replacement, only the manufacturers trained maintenance technicians are authorised to carry out component testing and replacement. Unauthorised work or the use of unauthorised replacement filters may result in a potentially dangerous situation and/or damage to the extractor unit and will invalidate the manufacturer's warranty.

Cleaning the unit

The powder coat finish units can be cleaned with a damp cloth and non-aggressive detergent, do not use an abrasive cleaning product as this will damage the finish.

The cooling inlets and outlets should be cleaned once a year to prevent build-up of dust and overheating of the unit.

Replacing Filters

The FumeCab 700 system will alert the user when its filters need replacing when the red filter change indicator light on the control panel glows.

Fire Risk Warning

In the very rare event that a burning ember or spark is drawn into the fume extraction unit, it may be possible that the filters will ignite. Whilst any resultant fire would typically be retained within the fume extraction unit, the damage to the extractor would be significant. It is therefore essential to

minimise this risk by undertaking an appropriate assessment to determine:-

- a). Whether additional fire protection equipment should be installed.
- b). Appropriate maintenance procedures to prevent the risk of build-up of debris which could potentially combust.

A log of the changes should be maintained by the user. The filters require attention when the display shows the filter blocked icon/ filter output signal (if fitted) or when the extractor no longer removes fume efficiently.

All filters are tested to BS3928. A certificate of conformity for each filter is available on request.

It is recommended that a spare set of filters are kept on site to avoid prolonged unit unavailability. Part numbers for replacement filters can be found on the filters fitted in your system.

To prevent overheating, units should not be run with a blocked filter condition, or with dust obstruction of Inlets / Outlets.

Maintenance

6₀₂

Pre-Filter Replacement

To remove and replace the Pre filter follow the procedure detailed below.

1. Isolate the electrical supply to the extractor
2. Lift the Perspex panel. Unscrew the two knurled knobs inside the unit allowing the hinged pre filter to drop down. Remove the pre filter from the tray and replace it with a new, unused BOFA pre filter. Once removed it is recommended that the used filters are bagged and sealed.
3. Lift the tray back into position and screw the two knurled knobs back in place. Close the Perspex panel

Combined Filter Replacement

The Combined filter needs replacing when the red filter change indicator located on the control panel glows.

To remove and replace the combined filter follow the procedure detailed below.

1. Isolate the electrical supply to the extractor
2. Undo the catch on the front of the unit and open the filter door.
3. Rotate the lever below the filter through 180° to lower the combined filter.
4. Using the handle on the front of the filter, pull it out of the unit being careful to support it as it comes free as it is heavy.
5. Once removed it is recommend that the used filters are bagged and sealed.
6. Slide the new filter into position making sure it is pushed in all the way.
7. Rotate the lever back through 180° to raise the filter into position.
8. Close the door and fasten the latch
9. Reconnect the power supply

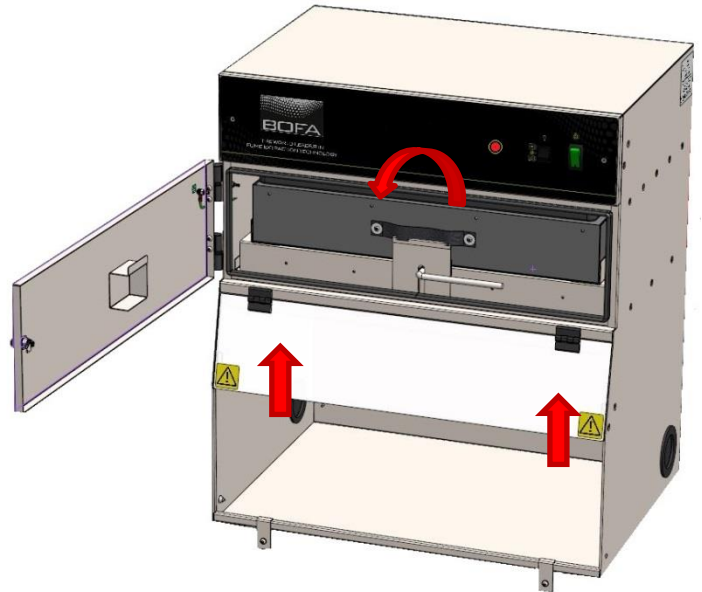

Both filters MUST be fitted when the extractor is in use.

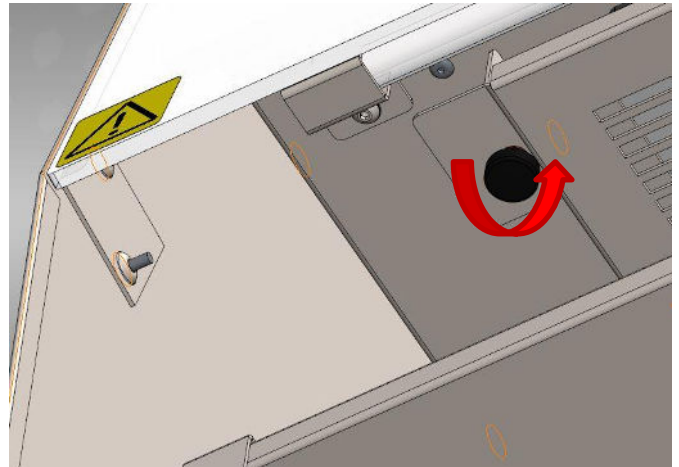

Replacement Parts



Consumable Spares

The FumeCab 700b extraction system contains a pre filter and a combined filter. These should be replaced when instructed to do so by the FumeCab system (see section 6 for replacing the filters)

To maintain performance it is important that the filters are replaced with identical BOFA filters. To re-order please refer to the Filter number printed on the filter installed in your extraction unit.

Maintenance Protocol

Users may wish to record changes on the table below.

Unit Serial Number:			
Pre filter		Combined filter	
Date	Engineer	Date	Engineer

Filter disposal

The Pre and Combined filters are manufactured from non-toxic materials. Filters are not re-usable, cleaning used filters is not recommended. The method of disposal of the used filters depends on the material deposited on them.

For your guidance

Deposit	EWC Listing*	Comment
Non Hazardous	15 02 03	Can be disposed of as non-hazardous waste.
Hazardous	15 02 02M	The type of hazard needs to be identified and the associated risks defined. The thresholds for these risks can then be compared with the amount of material in the filters to see if they fall into the hazardous category, if so, the filters will need to be disposed of in line with the local/national regulations.

*European Waste Catalogue

System Specifications



Unit: FumeCab 700

Face Velocity: 0.4m/s

Weight: 70Kg (154.3lbs)

Motor: Centrifugal Fan

Output: 320w

Electrical supply: 115V

Hertz: 60Hz

Full Load Current: 3A

Noise Level: Below 60dB (A)

(at typical operating speed)

Size:

	Metric (mm)	Imperial (inches)
Height	780	30.7
Depth	490	19.3
Width	690	27.1

Filters:

Filter Type	Surface area	Efficiency
Pre filter	1.68 m ²	99% @ 0.3micron
Combined filter	3.0m ²	99.997% @ 0.3micron

Combined Filter (Gas section)

Filter Type	Carbon type	Amount
Combined filter (Gas)	Activated carbon	17kgs

Environmental operating range:

Temperature: +5°C to + 40°C

Humidity: Max 80% RH up to 31°C

Max 50% RH at 40°C

Contact Information

BOFA Headquarters

19-20 Balena Close
Creekmoor industrial Estate
Poole
Dorset
BH17 7DU
UK
Phone: +44 (0) 1202 699 444

BOFA Americas

303 S.Madison Street
Staunton
Illinois
62088
USA
Phone: +1 (618) 205 5007

BOFA International GmbH

Sudring 62
D-21465
Wentorf bei Hamburg
Germany
Phone: +49 (0) 40 7393735-15